

ASSEMBLY INSTRUCTIONS
SKU: ERTB

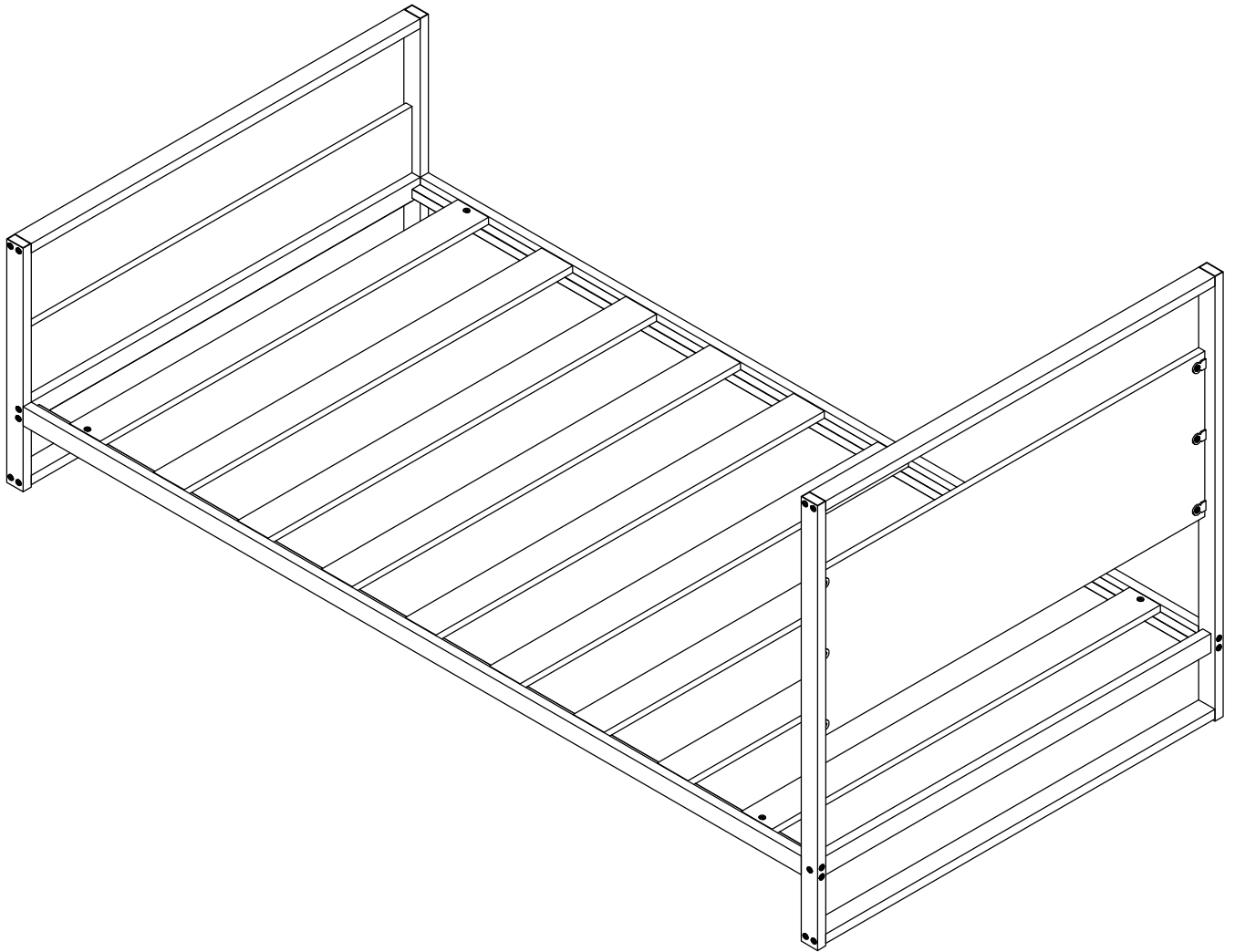

175 Southbelt Industrial Drive,
Houston, TX 77047

Email: info@eastwestfurniture.net



Description : *ERIE TWIN BED*
Dimension : 78"L x 37.8"W x 36.6"H

Cube Size 1 : 78.3" x 18.1" x 3.5"

NW: 48.4 LBS
GW: 55 LBS

ERIE TWIN BED

PART LIST

1

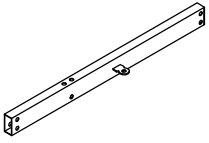

1PC

2

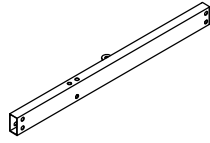

1PC

3

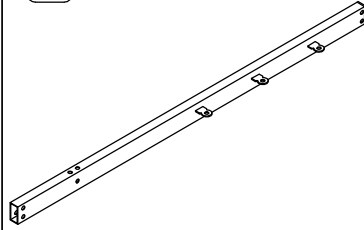

1PC

4

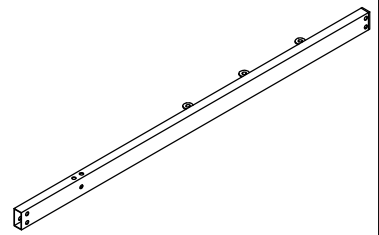

1PC

5

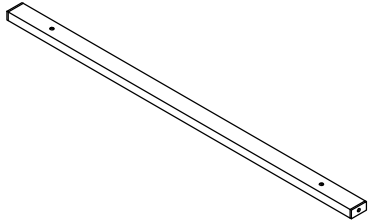

1PC

6

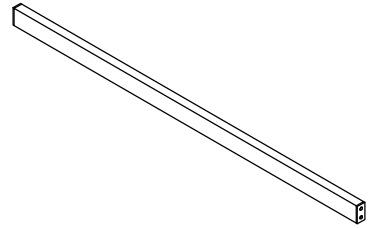

4PCS

7

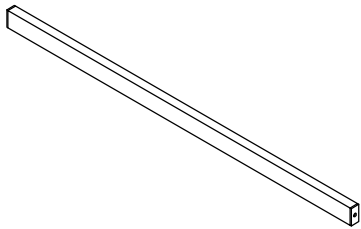

1PC

8



2PCS

9

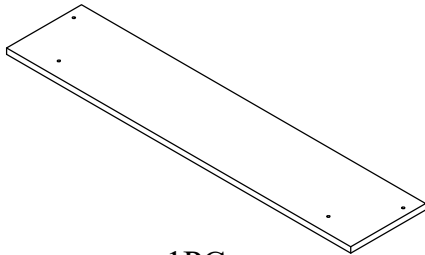

1PC

10

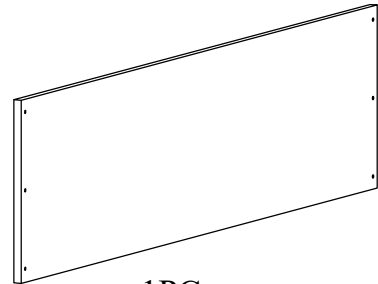

1PC

11

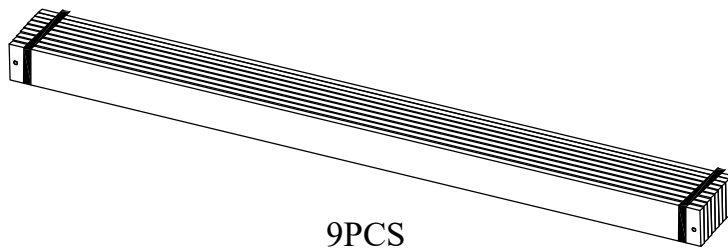







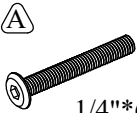
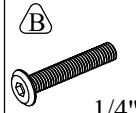
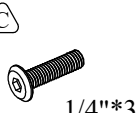
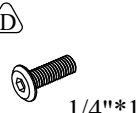
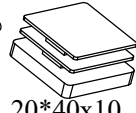
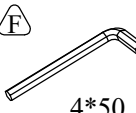



9PCS

ERIE TWIN BED

HARDWARE LIST

 1/4"*60 8PCS	 1/4"*40 20PCS	 1/4"*30 6PCS	 1/4"*12 8PCS	 20*40x10 4PCS	 4*50 2PCS
--	---	--	--	---	---

IMPORTANT SAFETY NOTICE: READ CAREFULLY BEFORE BEGINNING ASSEMBLY!

-  Keep desiccant, hardware packs and small components away from children, avoid eating and injuring.
-  Please do follow assembly steps.
-  Please do not lock any screws before each assembling unit is well placed at appropriate position.
-  Please do make sure all components are firmly locked after assembly and before use to avoid any potential safety hazard.
-  Please do use product correctly by it's origin purpose to avoid any danger happened.
-  Please do not stand on any part of components, except the ladder of this product after complete assembly.
-  If product is required to lock on the wall, please do so in case of any safety hazard happened before use.
-  Please check all contents of this product inside the carton (s) carefully, small parts may lost during shipment, if any of this happened, please contact the retailer from who you purchased this product to obtain replacement, do not use any substitute items.
-  This assembly instructions booklet contains important safety information, please read carefully before assembly and keep for further reference.
-  This products is designed referring to overall loading of each set final product, Please avoid to load on single point of final product making damaged
product name : Erie Twin Bed: overall loading : 400 LBS (maximum)

STEP 1

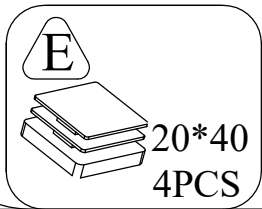
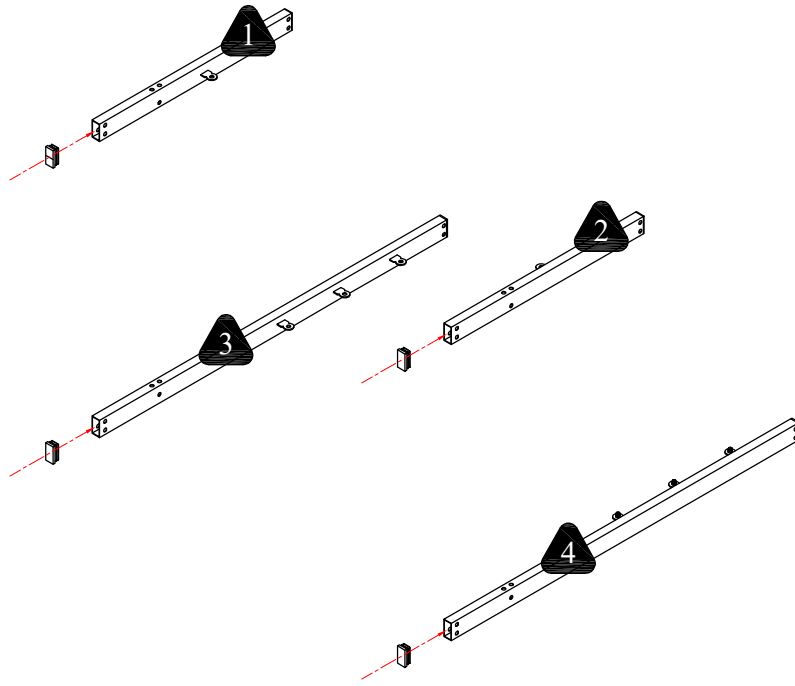

STEP 2

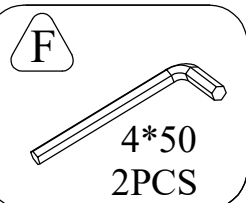
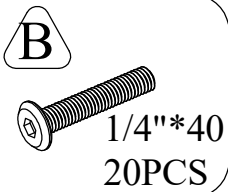
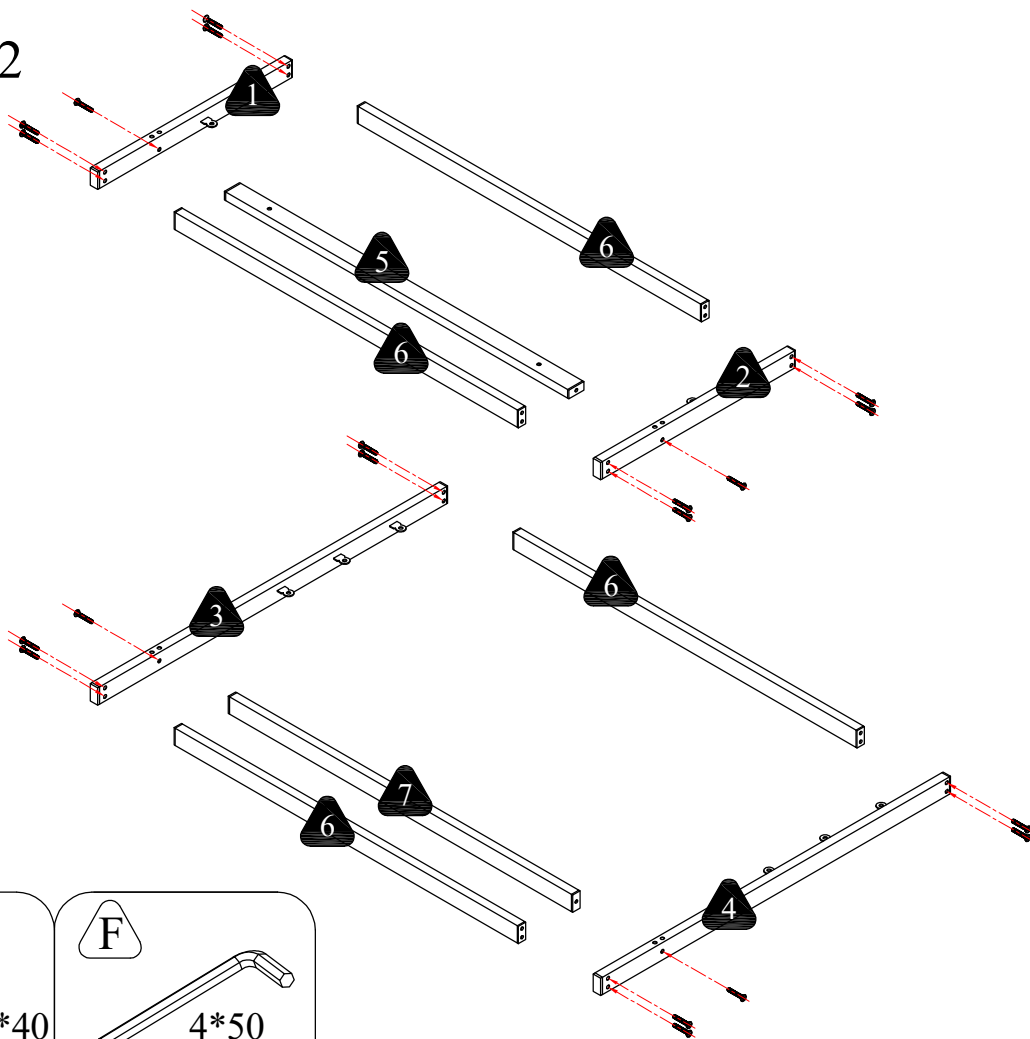

ERIE TWIN BED

STEP 3

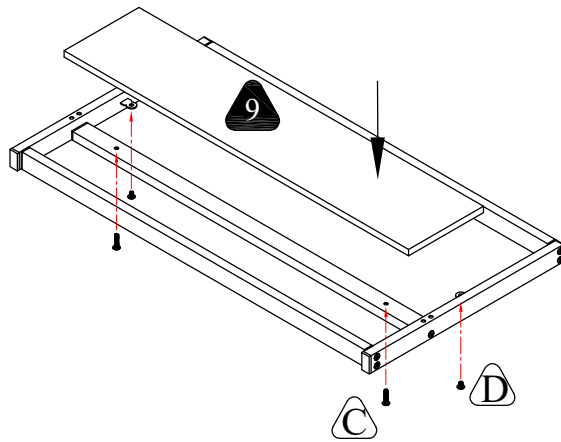

C

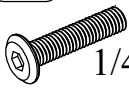

1/4"*30
2PCS

D



1/4"*12
2PCS

F

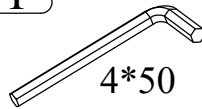

4*50
2PCS

STEP 4

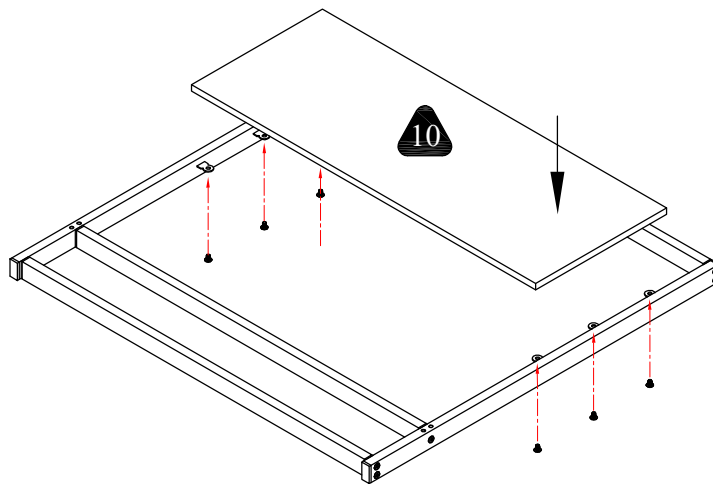

D



1/4"*12
6PCS

F



4*50
2PCS

STEP 5

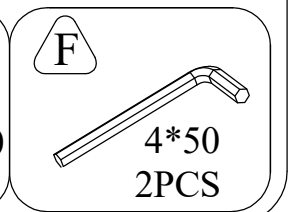
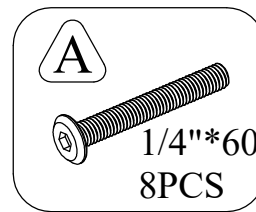
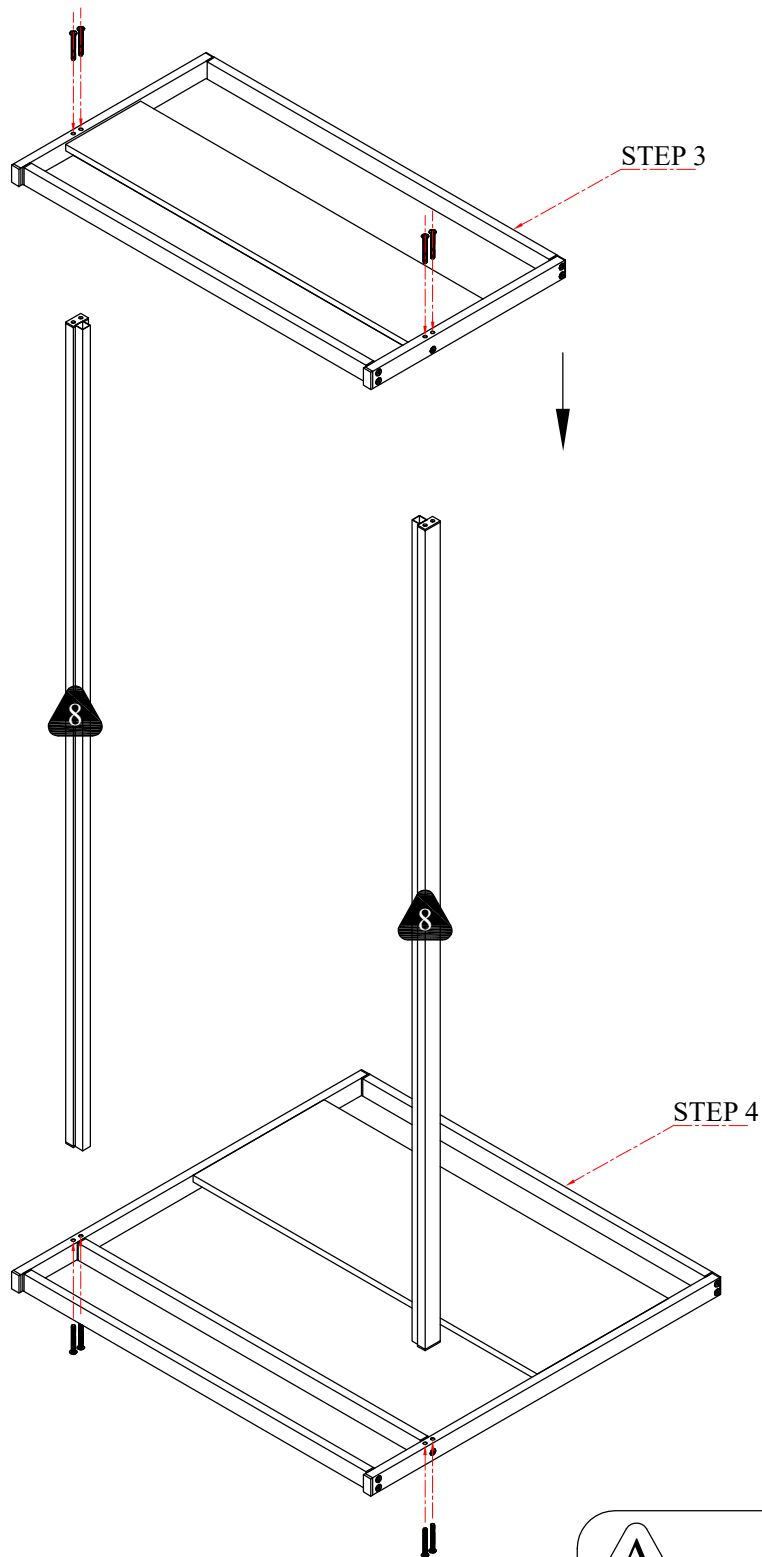

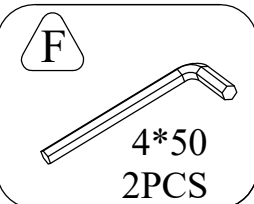
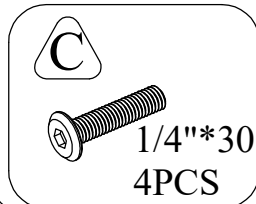
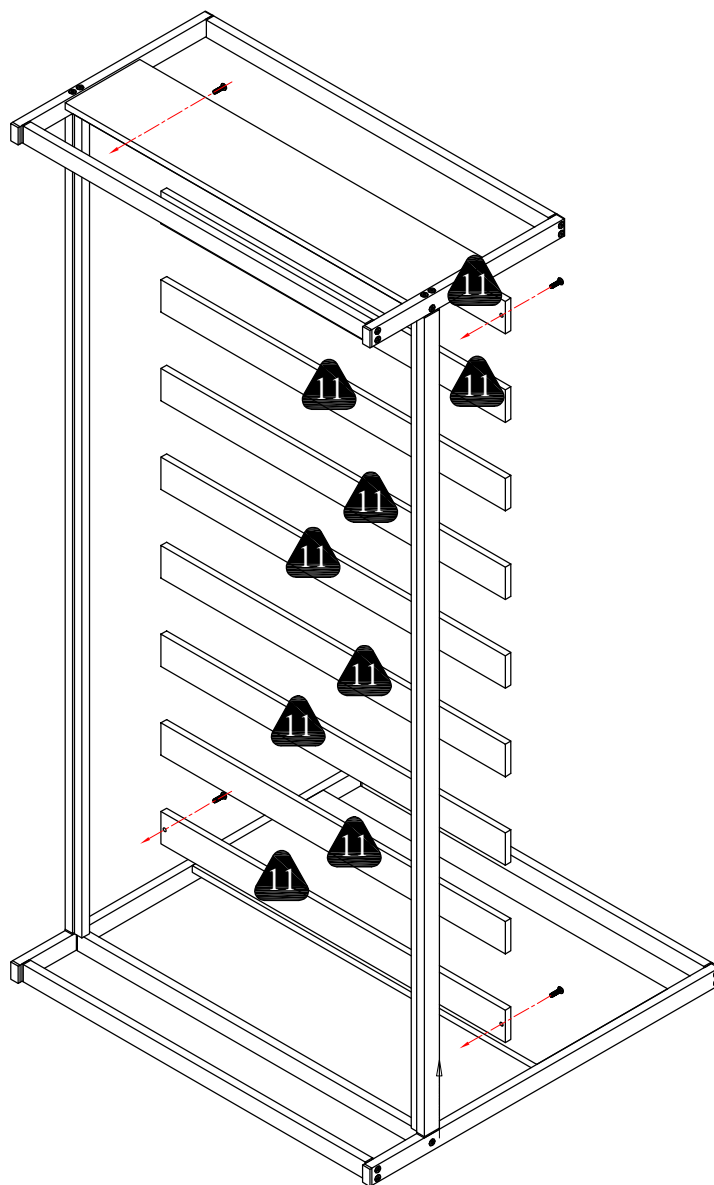

ERIE TWIN BED