

ASSEMBLY INSTRUCTIONS

SKU: IGFB

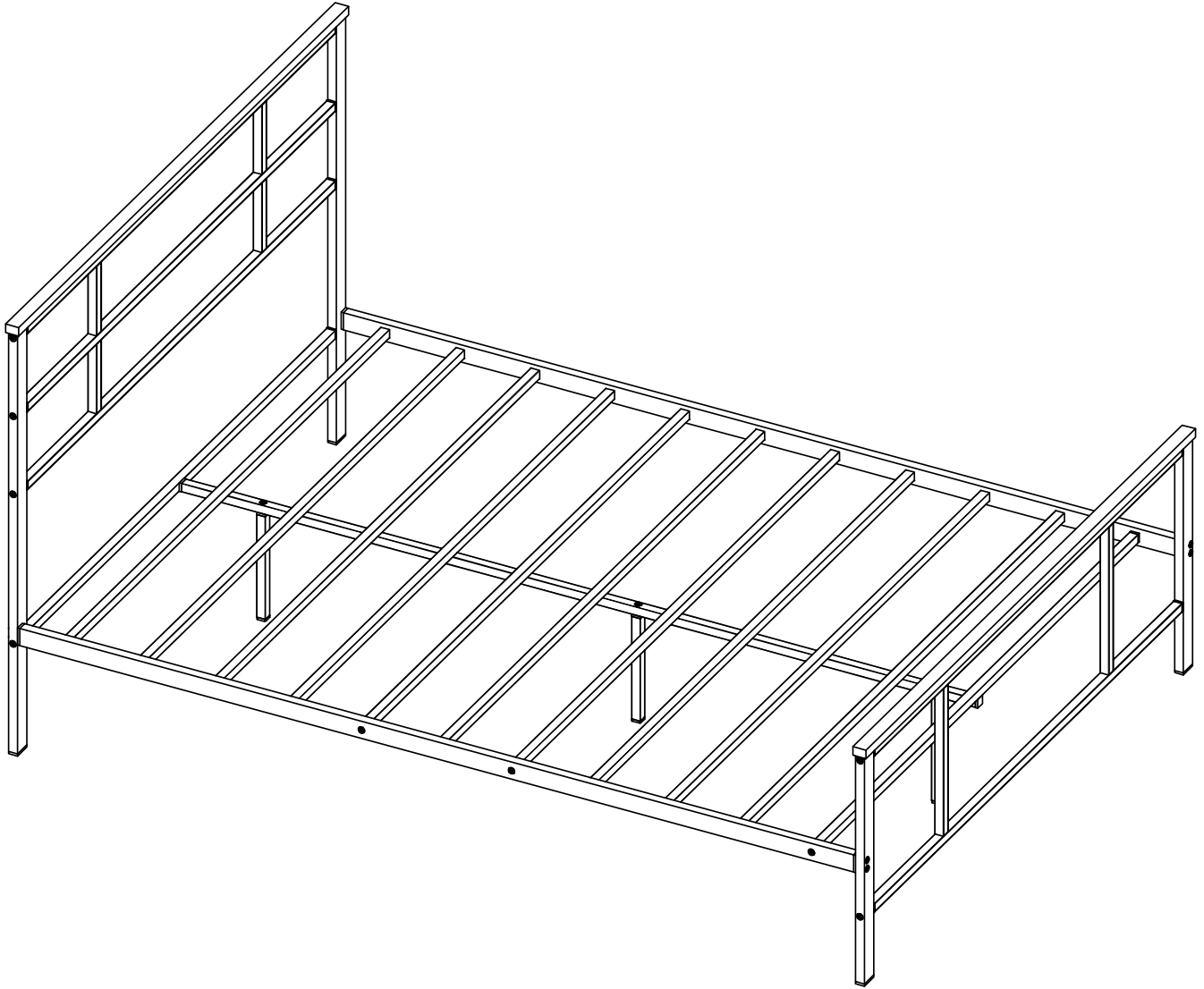

175 Southbelt Industrial Drive,  
Houston, TX 77047  
Email: [info@eastwestfurniture.net](mailto:info@eastwestfurniture.net)



Description : *INGRAM FULL BED*  
Dimension : 76.3L"x55.5"Wx39.3"H

Cube Size 1 : 76.8"x 16.7"x 4.5"



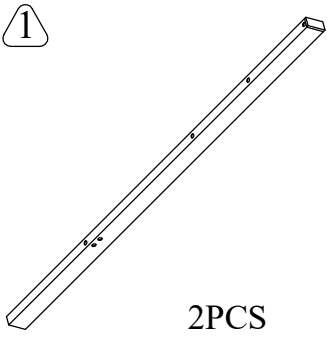
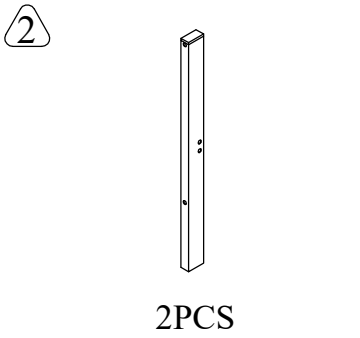
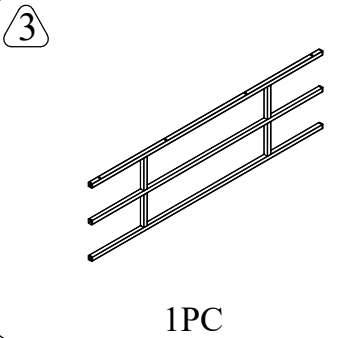
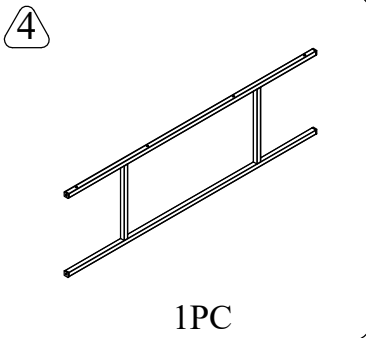
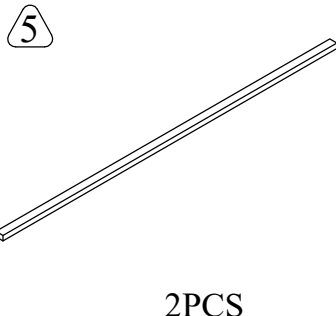
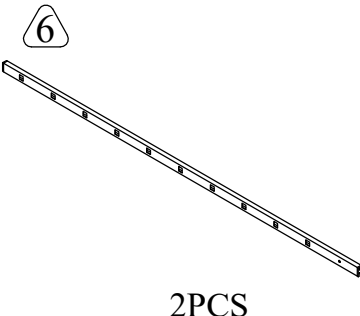
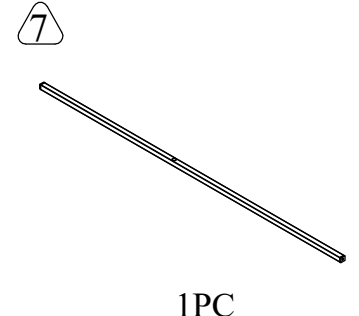
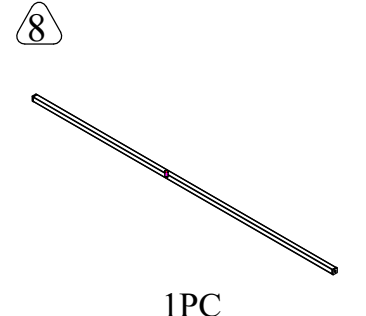
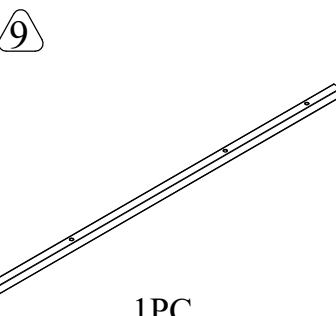
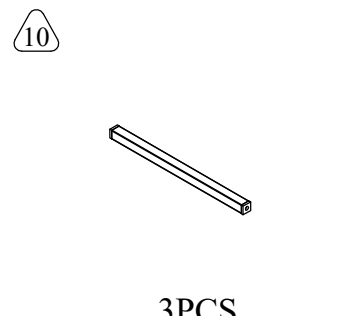
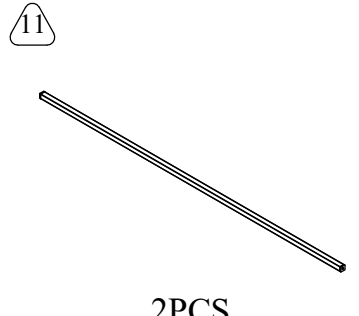
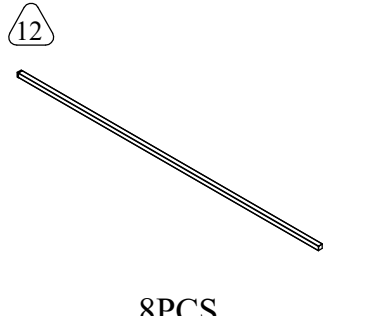

NW: 40.7 LBS  
GW: 47.3 LBS

*INGRAM FULL BED*

# PART LIST

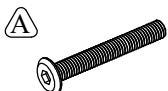
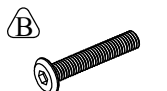
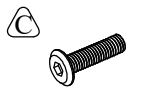
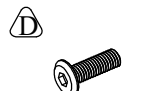
 <p>1 2PCS</p>	 <p>2 2PCS</p>	 <p>3 1PC</p>	 <p>4 1PC</p>
 <p>5 2PCS</p>	 <p>6 2PCS</p>	 <p>7 1PC</p>	 <p>8 1PC</p>
 <p>9 1PC</p>	 <p>10 3PCS</p>	 <p>11 2PCS</p>	 <p>12 8PCS</p>

# HARDWARE LIST

 <p>A 1/4"*60 12PCS</p>	 <p>B 1/4"*40 14PCS</p>	 <p>C 1/4"*30 9PCS</p>	 <p>D 1/4"*20 4PCS</p>	 <p>E 20x40x10 4PCS</p>	 <p>F 20x20x10 3PCS</p>	 <p>H 4x60 2PCS</p>
--	--	---	---	---	--	--

**INGRAM FULL BED**

## IMPORTANT SAFETY NOTICE: READ CAREFULLY BEFORE BEGINNING ASSEMBLY!

- ⚠ Hardware packs and small components should be away from the children, avoid eating and being injured
- ⚠ Please, follow with the assembly steps in order
- ⚠ Please, do not tighten any screw before each assembling unit is well placed in appropriate position
- ⚠ Please, make sure all components are fixed firmly locked without any potential safety hazard  
After assembly and before using
- ⚠ Please, use this product correctly, according to its purpose to avoid danger happened
- ⚠ Please, do not stand on any component of this product, except the ladder of this product after fixing locked safely
- ⚠ Such as the wall fastening devices are essential parts of this product. Please fix firmly locked without any potential safety hazard before using
- ⚠ Please check all contents of this product inside of carton (s) carefully, small parts may have been lost during shipment, if any! contact further with the retailer from which you purchased this product to obtain, do not use any substitute part
- ⚠ This assembly instructions booklet contains important safety information, please read and keep for further reference
- ⚠ This products is designed referring to overall loading of each set final product,  
Please avoid to load on single point of final product making damaged  
product name : Ingram Full Bed overall loading: 400 LBS (maximum)

### STEP 1

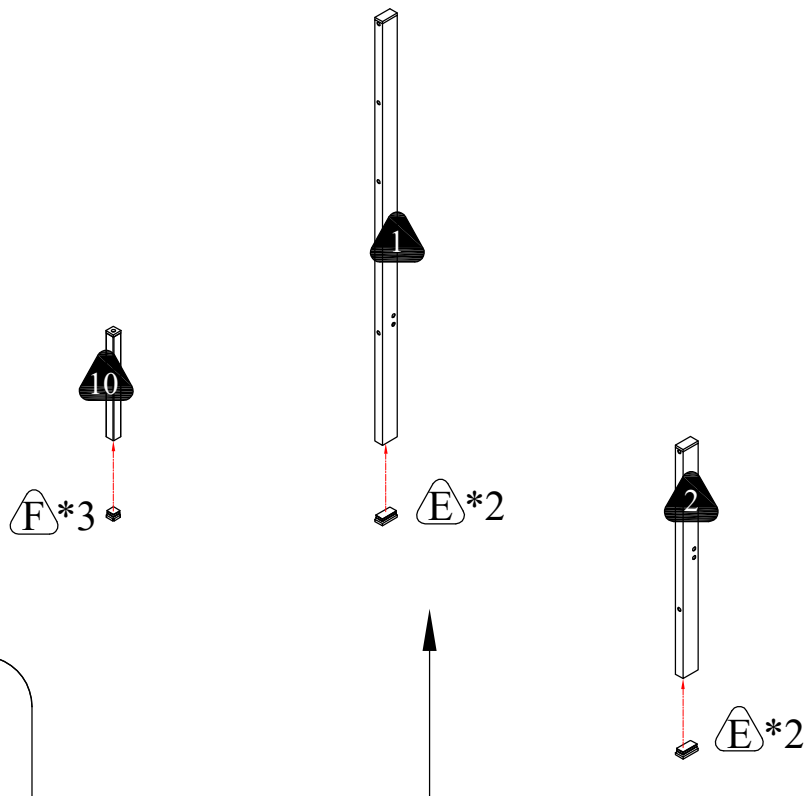

F

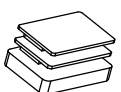

20x20x10  
3PCS

E

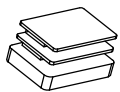

20x40x10  
4PCS

*INGRAM FULL BED*

## STEP 2

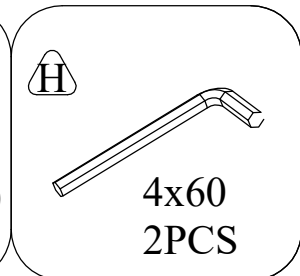
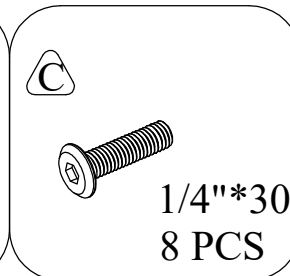
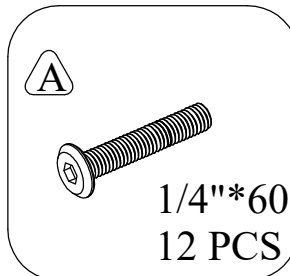
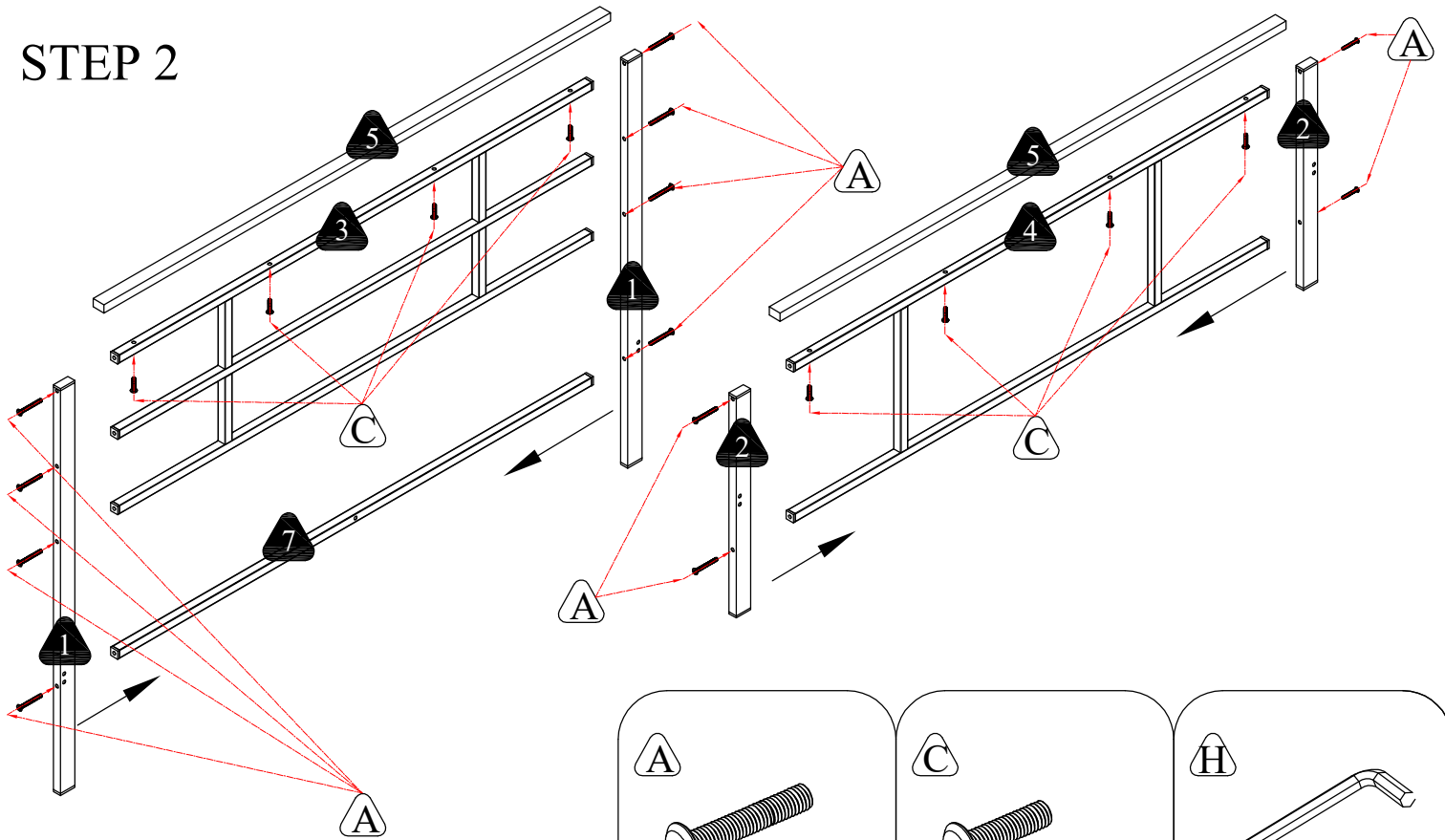

## STEP 3

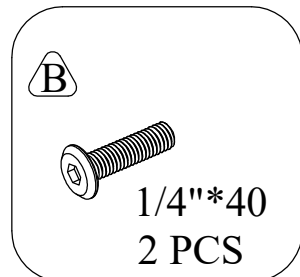
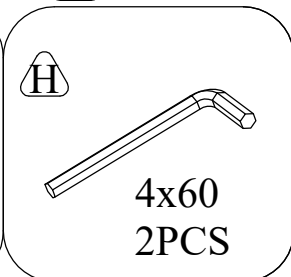
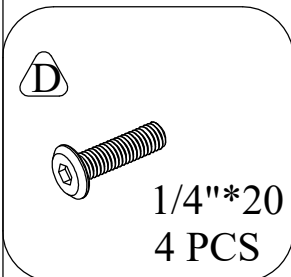
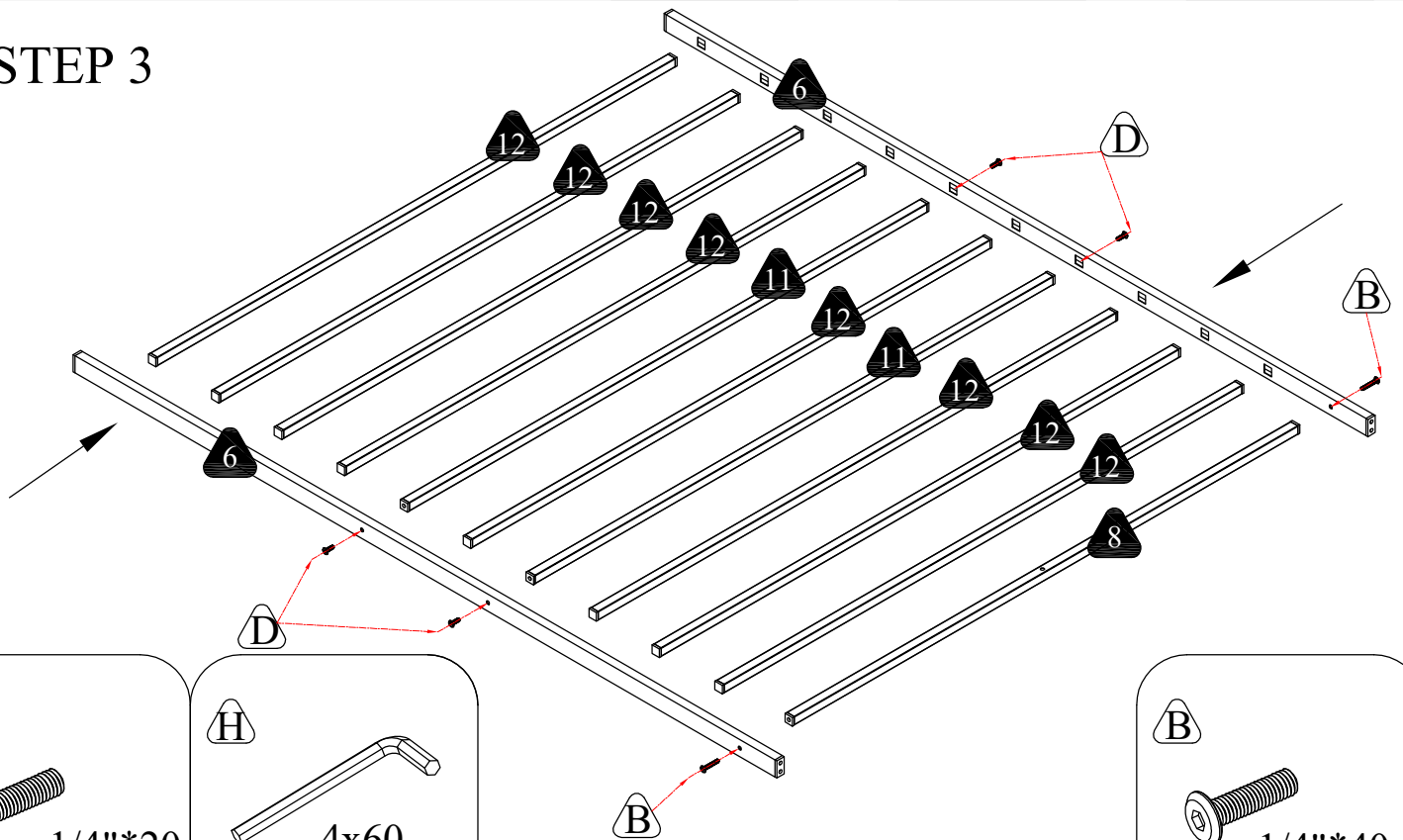

**INGRAM FULL BED**

# STEP 4

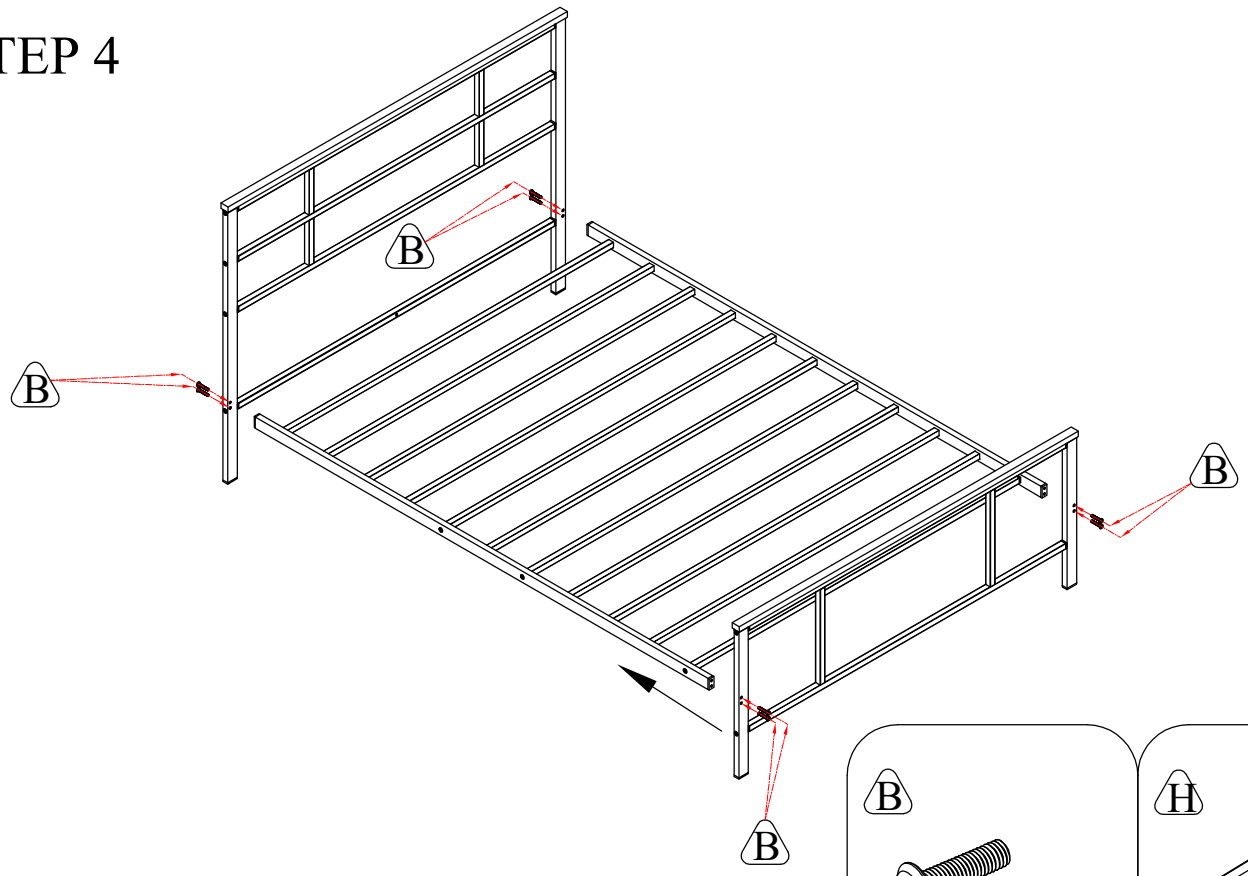

**B**

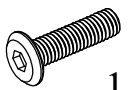

1/4"\*40  
8 PCS

**H**

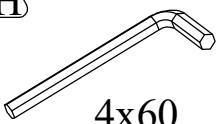

4x60  
2PCS

# STEP 5

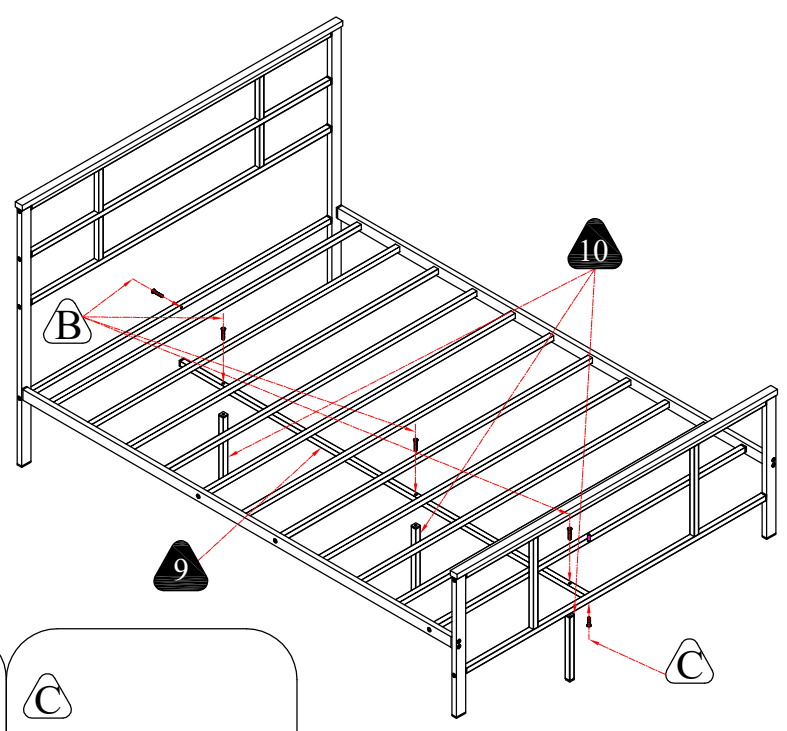

**B**

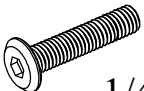

1/4"\*40  
4 PCS

**C**

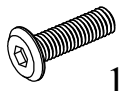

1/4"\*30  
1 PCS

**H**

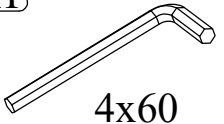

4x60  
2PCS

**INGRAM FULL BED**