

ASSEMBLY INSTRUCTIONS

SKU: IRT

Description : IRVING 48" ROUND DINING TABLE

Product Dimension : Ø48"x30"H

Cube Size : 50.3"x50.3"x3.5"
(TABLETOP)

NW: 37.4 LBS

GW: 44 LBS

MODEL 2

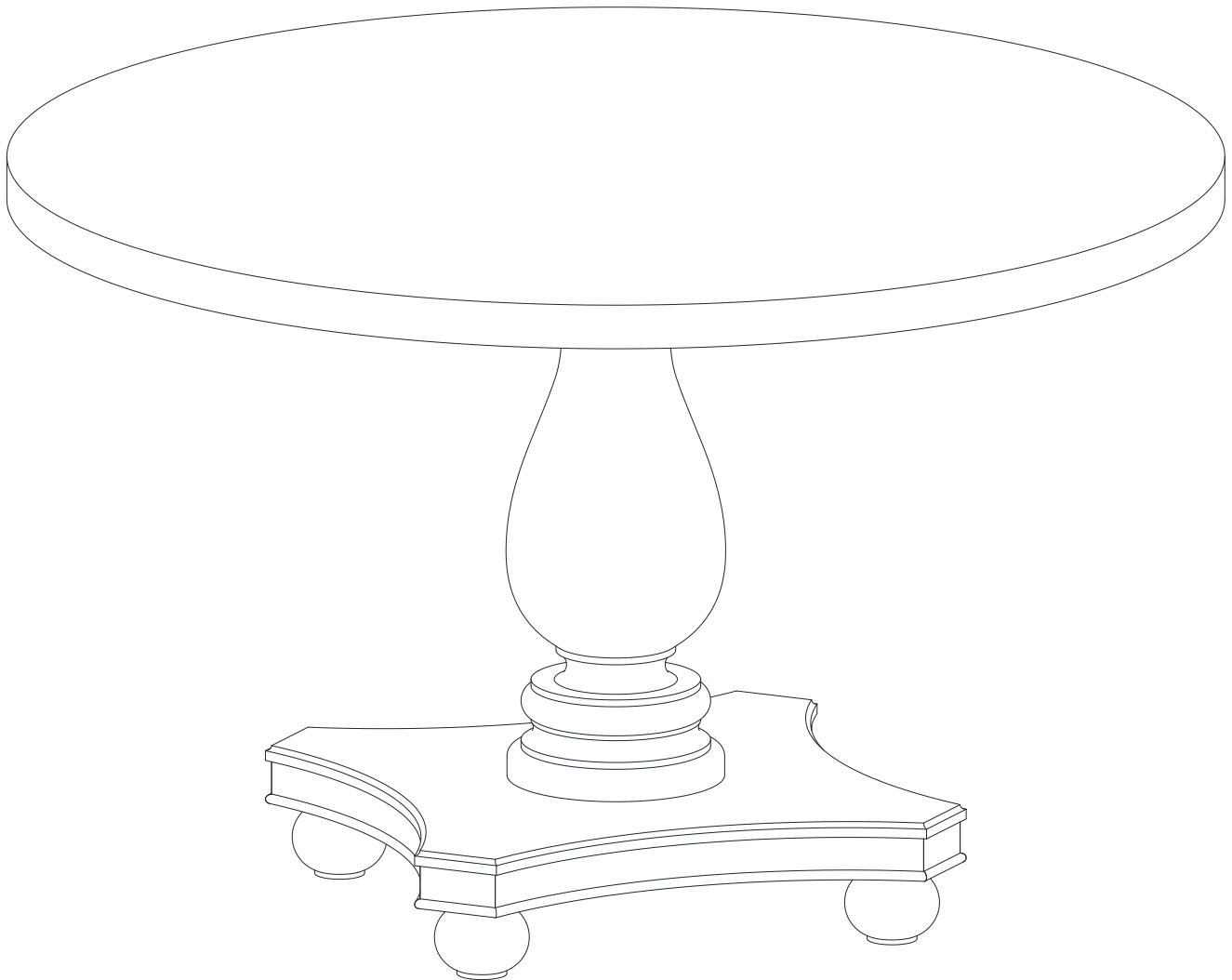

002-P PEDESTAL

BEFORE ASSEMBLY

Thank you for purchasing this quality product. This product has been designed for easy assembly and constructed for durability. Please take the time to read and follow the assembly instructions carefully.

Be sure to check all packing material carefully for small parts which may have come loose inside the carton during shipment. Please separate, identify, and count all parts and metal hardware. Compare with part list to be sure all parts are present.

If hardware is missing or you have difficulty assembling this product, please call for us.

IMPORTANT NOTE:

- Place all wooden parts on a clean and smooth surface such as a rug or carpet to avoid the parts from being scratched.
- Remove all wrapping material, including staples & packing straps before you start to assemble.
- DO NOT tighten all screws and bolts until completely assembled.
- Keep all hardware parts out of reach of children.

PART LIST



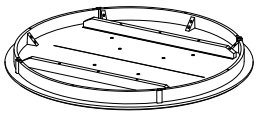
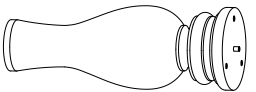
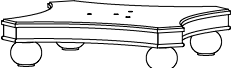
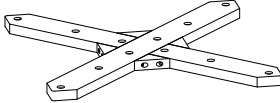

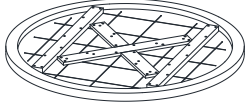
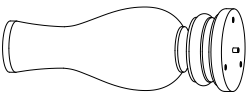
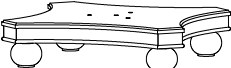
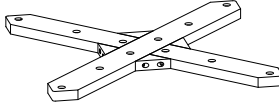

When unpacking, please be careful not to discard any parts with the packaging. Before continuing, please make sure you have the following parts:

MODEL 1			
NO	Description	Qty	Sketch
A	Table Top (FET)	1	
B	Pedestal	1	
C	Foot Flat from	1	
D	Cross piece	1	

MODEL 2			
NO	Description	Qty	Sketch
A	Table Top (IRT)	1	
B	Pedestal	1	
C	Foot Flat from	1	
D	Cross piece	1	

HARDWARE LIST

When unpacking, please be careful not to discard any parts with the packaging. Before continuing, please make sure you have all of the following hardware:

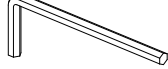
NO	Description	Qty	Sketch	NO	Description	Qty	Sketch
1	Long bolt (M8x60mm)	3		2	Medium bolt (M6x40mm)	4	
3	Short bolt (M6x30mm)	8		4	Large lock washer (Φ8.5xΦ13mm)	3	
5	Large flat washer (Φ8.5xΦ19mm)	3		6	Small lock washer (Φ6.5xΦ9mm)	4	
7	Small flat washer (Φ6.5xΦ13mm)	4		8	Allen key (M4)	1	

002-P PEDESTAL

STEP 1

Attach the Foot Flatfrom (D) to the Pedestal (B) with long bolt (1) and washer (4), (5). Tighten with Allen key (8).

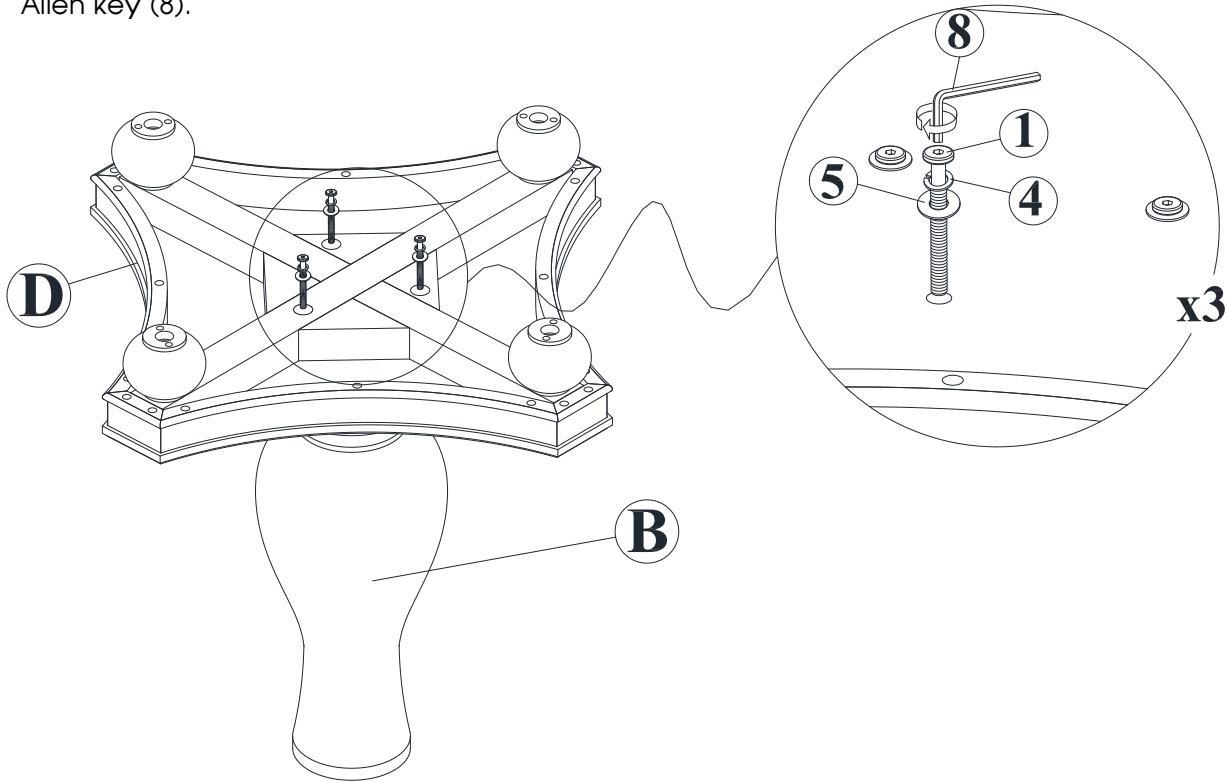

STEP 2

Put the Cross piece (C) on top of the Pedestal (B), and attach with medium bolts (2), washers (6), (7). Tighten with Allen key (8).

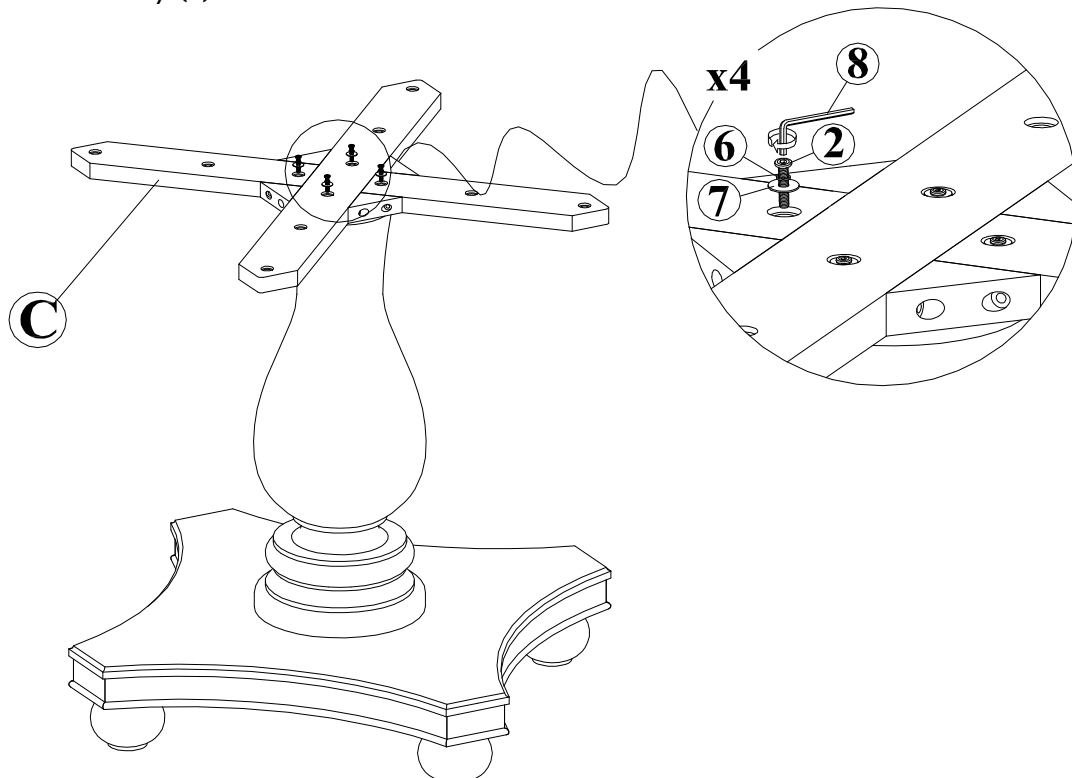

002-P PEDESTAL

STEP 3 (IRT)

Carefully place the Cross piece (from Step 2) on bottom side of the table top (A), attach with short bolts (3). Tighten with Allen key (8)

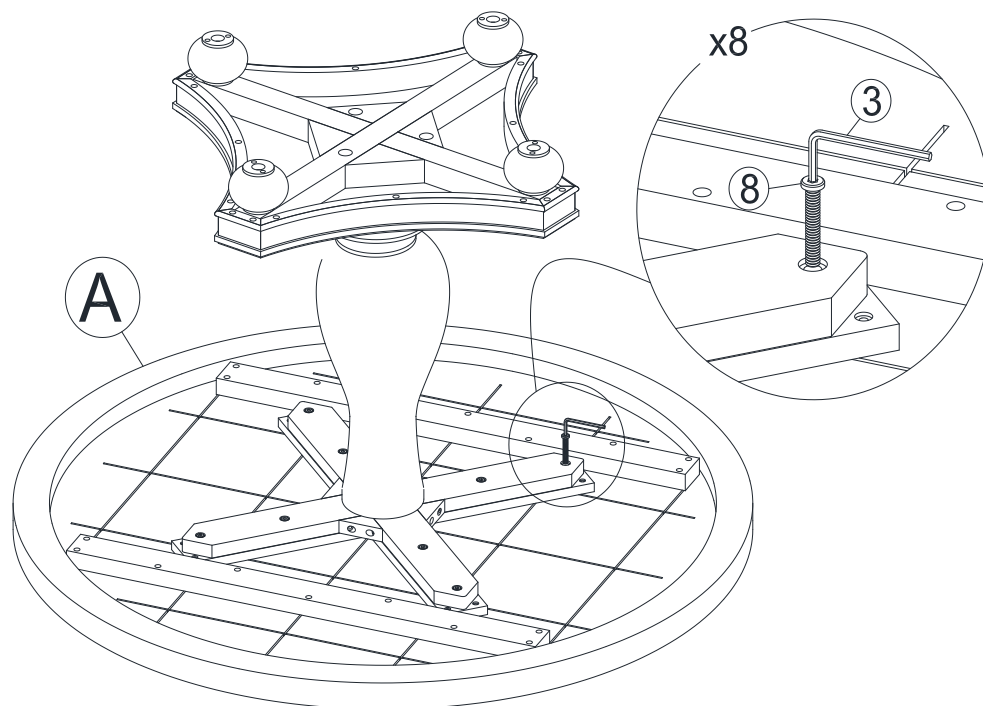

STEP 4 (IRT)

Flip the table and put on flat ground. Complete the assembly

