

ASSEMBLY INSTRUCTIONS
SKU: ATQC

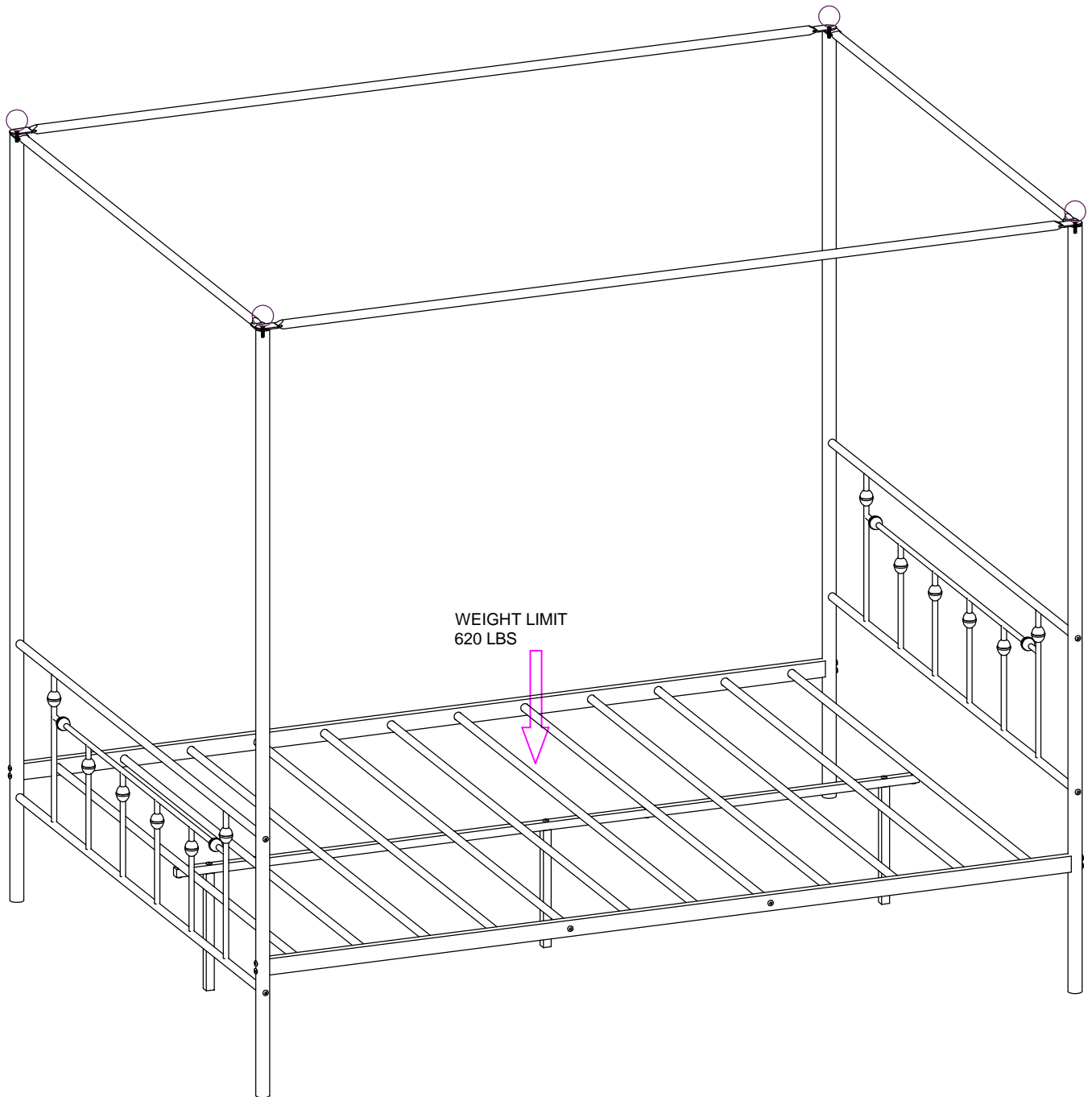

175 Southbelt Industrial Drive,
Houston, TX 77047

Email: info@eastwestfurniture.net



Description : ***ANNISTON QUEEN CANOPY BED***

Dimension : 82.3"Lx62.3"Wx77"H

Cube Size : 83.5"x17.3"x4.3"

NW: 52.8 LBS

GW: 61.2 LBS



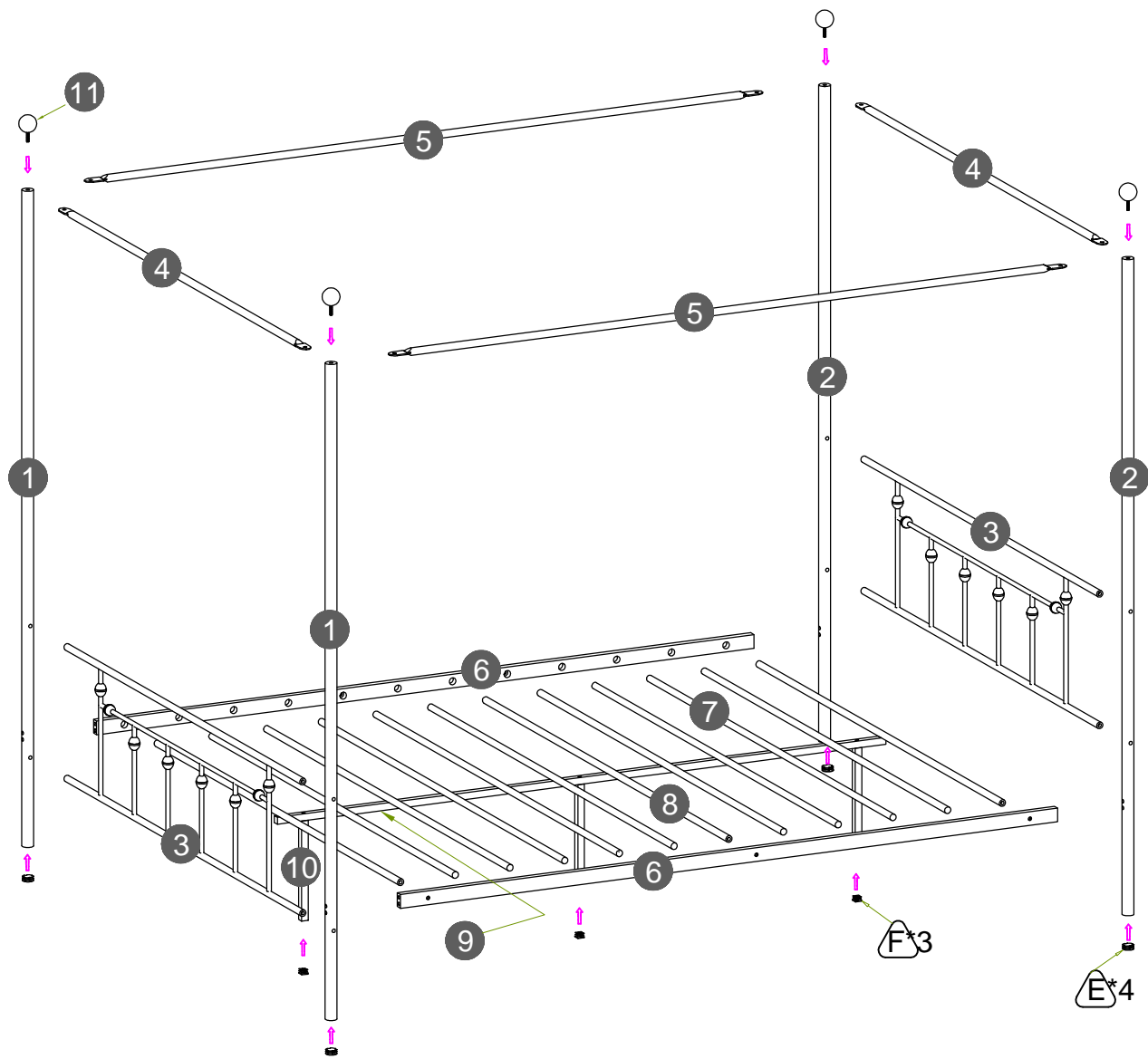

ANNISTON QUEEN CANOPY BED





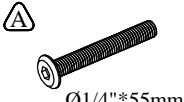



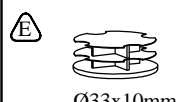
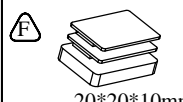
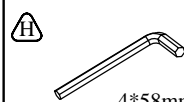



PART LIST

vertical bar - 2pcs	vertical bar - 2pcs	headboard & footboard - 2pcs	horizontal bar - 2pcs
horizontal bar - 2pcs	horizontal bar - 2pcs	slat - 9pcs	slat - 3pcs
horizontal bar - 1pc	vertical bar - 3pcs	ornament ball - 4pcs	

HARDWARE LIST

 A Ø1/4"*55mm	 B Ø1/4"*40mm	 C Ø1/4"*35mm	 D Ø1/4"*15mm	 E Ø33x10mm	 F 20*20*10mm	 H 4*58mm
Bolts - 16pcs	Bolts - 3pcs	Bolts - 3pcs	Bolts - 6pcs	Pipe plug - 4pcs	Pipe plug - 3pcs	Allen key - 1pc

IMPORTANT SAFETY NOTICE: READ CAREFULLY BEFORE BEGINNING ASSEMBLY!

-  Hardware packs and small components should be away from the children, avoid eating and being injured
-  Please, follow with the assembly steps in order
-  Please, do not tighten any screw before each assembling unit is well placed in appropriate position
-  Please, make sure all components are fixed firmly locked without any potential safety hazard After assembly and before using
-  Please, use this product correctly, according to its purpose to avoid danger happened
-  Please, do not stand on any component of this product, except the ladder of this product after fixing locked safely
-  Such as the wall fastening devices are essential parts of this product. Please fix firmly locked without any potential safety hazard before using
-  Please check all contents of this product inside of carton (s) carefully, small parts may have been lost during shipment, if any! contact further with the retailer from which you purchased this product to obtain, do not use any substitute part
-  This assembly instructions booklet contains important safety information, please read and keep for further reference
-  This products is designed referring to overall loading of each set final product, Please avoid to load on single point of final product making damaged
product name : **ANNISTON QUEEN CANOPY BED** : 620 LBS (maximum)

STEP 1.

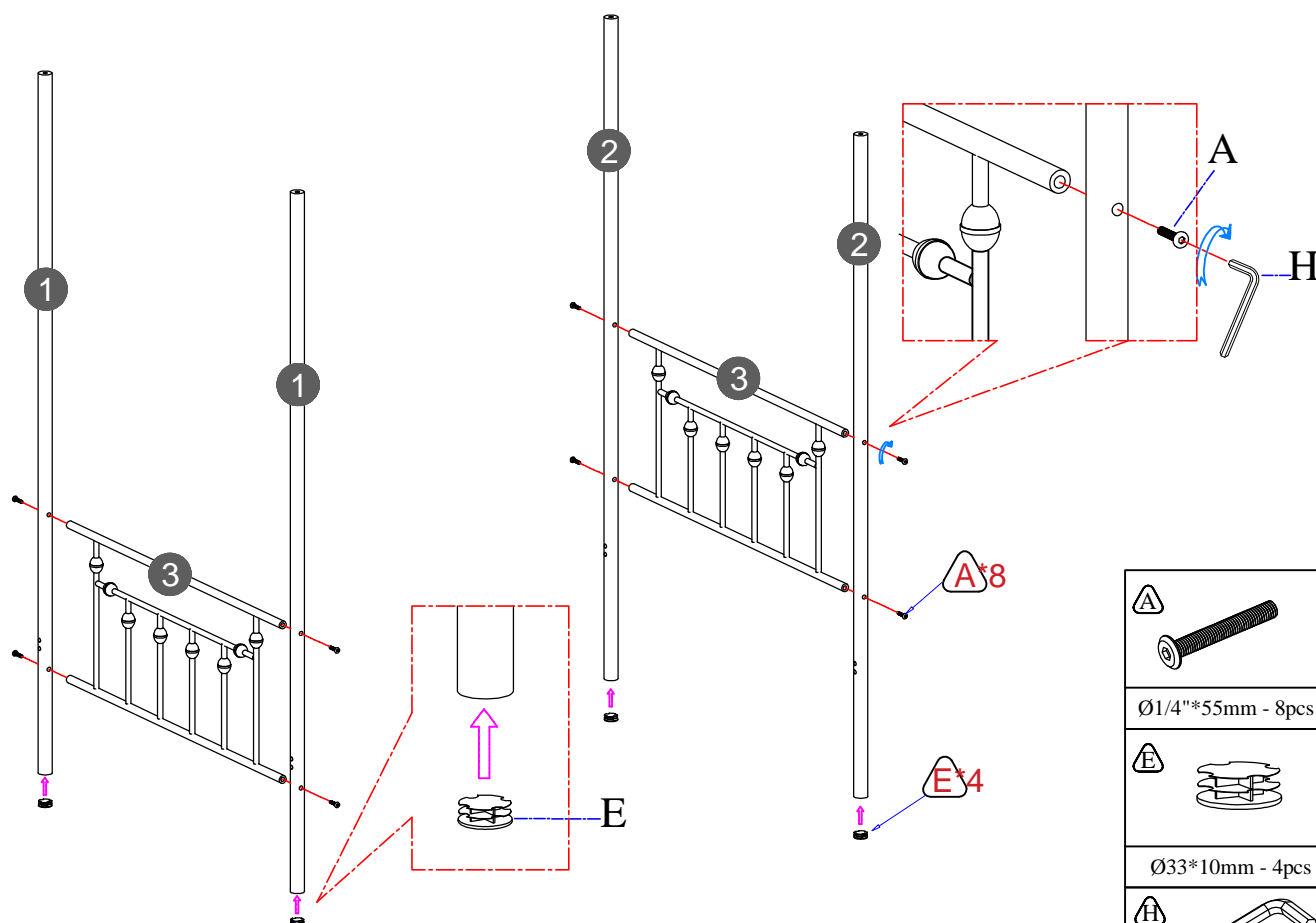

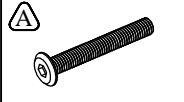
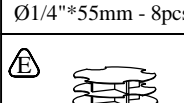
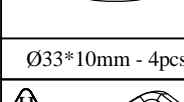
 A Ø1/4"*55mm - 8pcs
 E Ø33*10mm - 4pcs
 H

STEP 2.

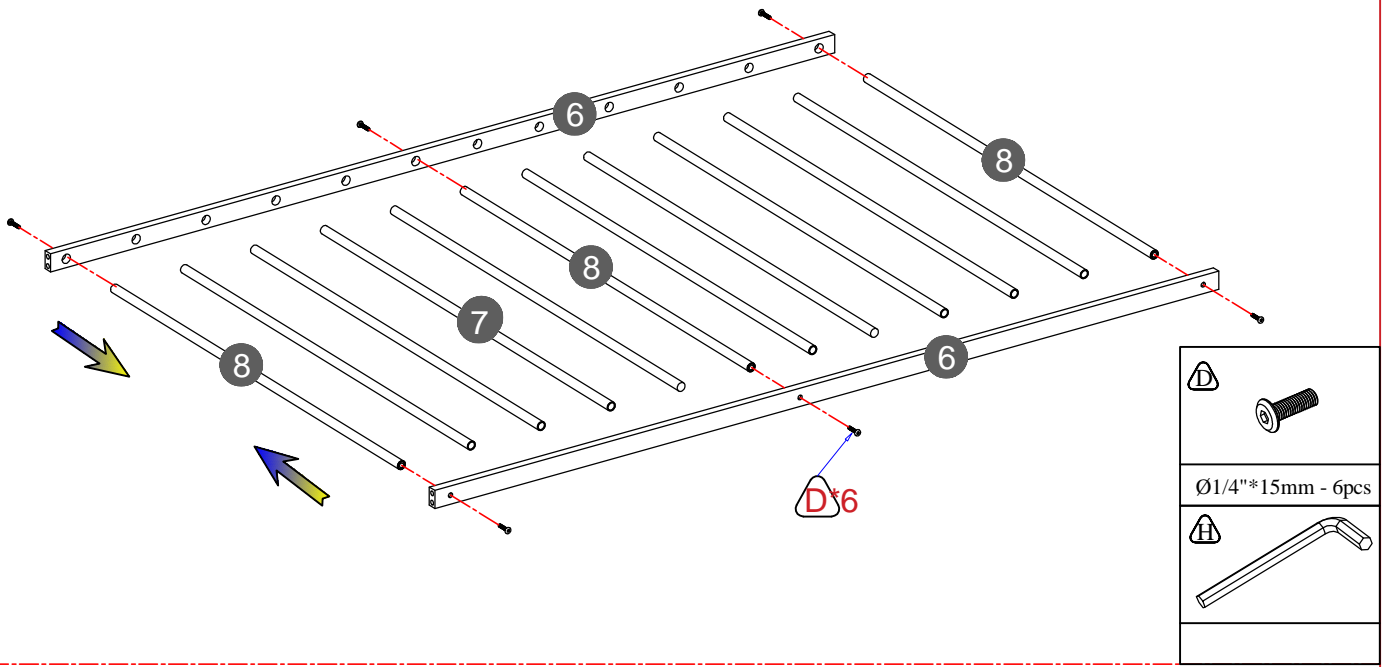



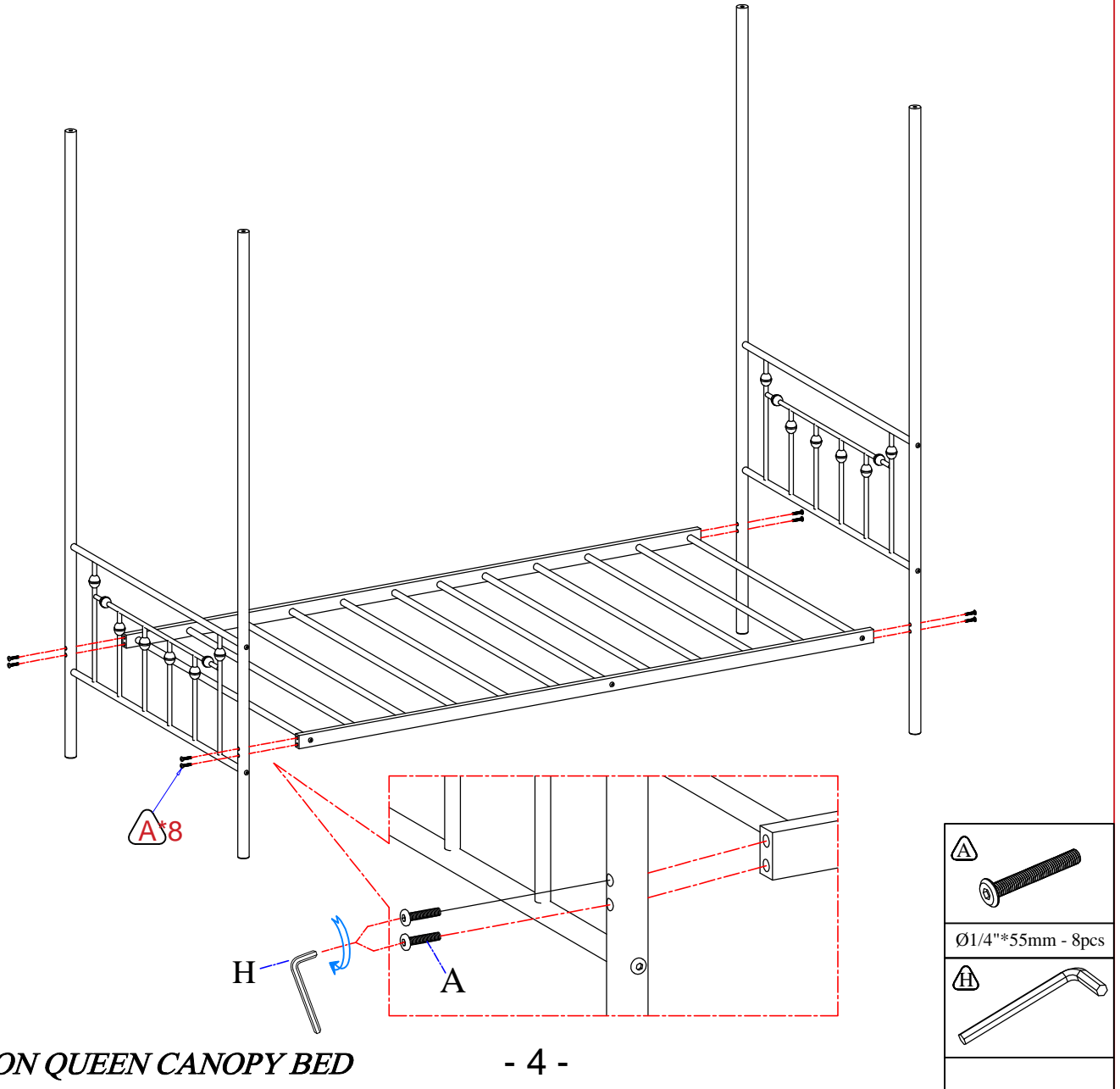

STEP 3.

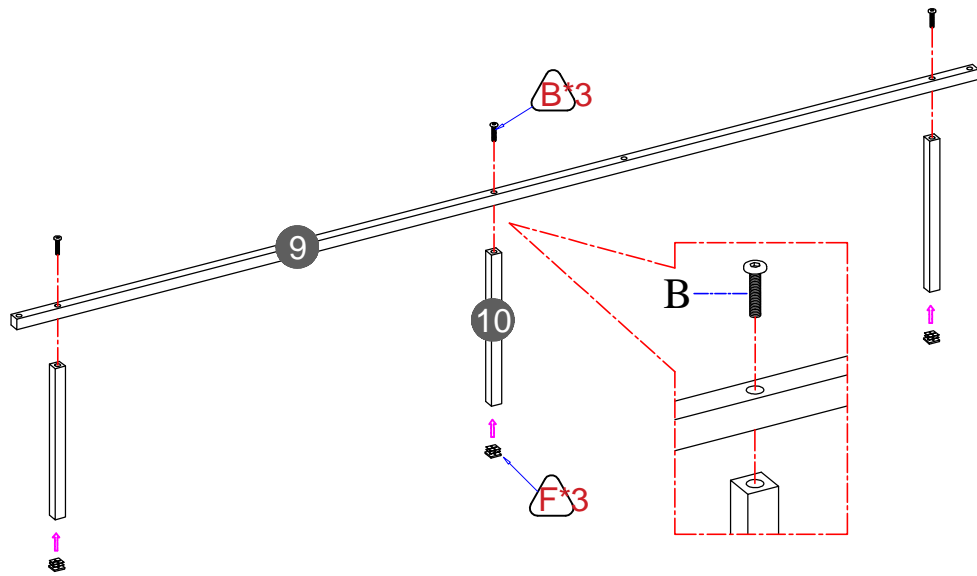

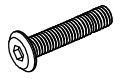

STEP 4.

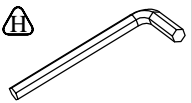

	
	Ø1/4"*40mm - 3pcs
	
	20*20*10mm - 3pcs
	

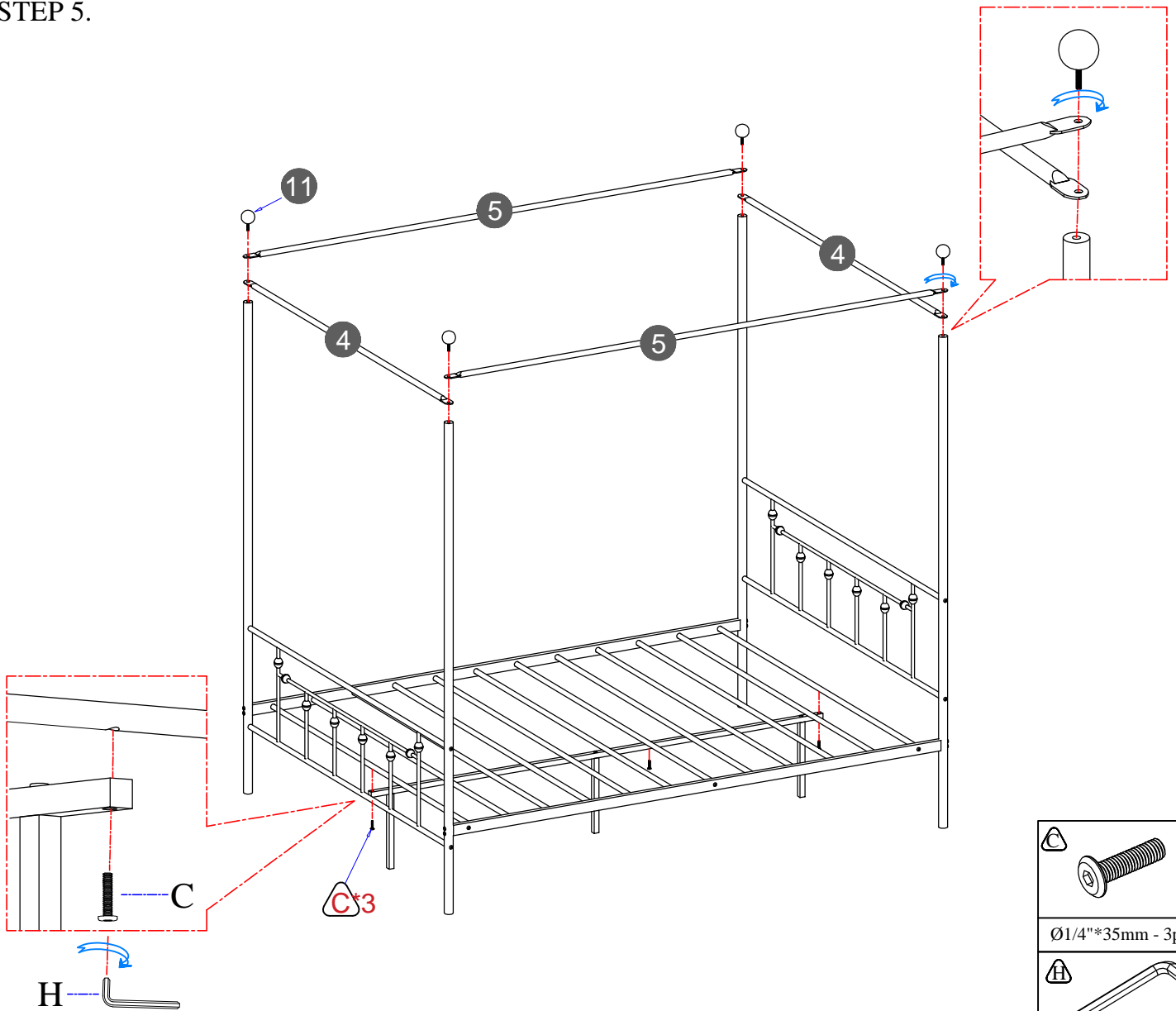
STEP 5.

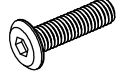

	
	Ø1/4"*35mm - 3pcs
