

ASSEMBLY INSTRUCTIONS

SKU: GONE



175 Southbelt Industrial Dr,
Houston, TX 77047

Email: sales@eastwestfurniture.net

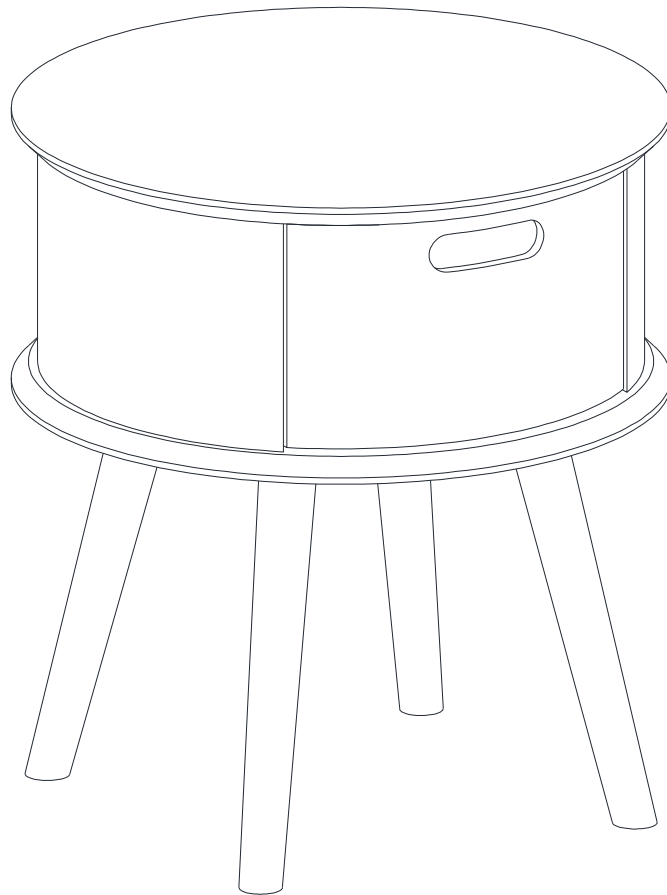

Description: Gordon Round Night Stand End Table

Product Dimension: 19.6"Wx19.6"Dx22"H

Cube Size : 21.2"x21.2"x10"

NW: 19.8 LBS

GW: 19.8 LBS

Gordon Round Night Stand End Table

BEFORE ASSEMBLY

Thank you for purchasing our product. This product has been designed for easy assembly and long lasting use. Please take the time to read and follow the assembly instructions carefully.

Be sure to check all packing material carefully for small parts which may have come loose inside the carton during shipment. Please separate, identify, and count all parts and metal hardware. Compare with part list to be sure all parts are present. If hardware is missing or you have difficulty assembling this product, please call for us.

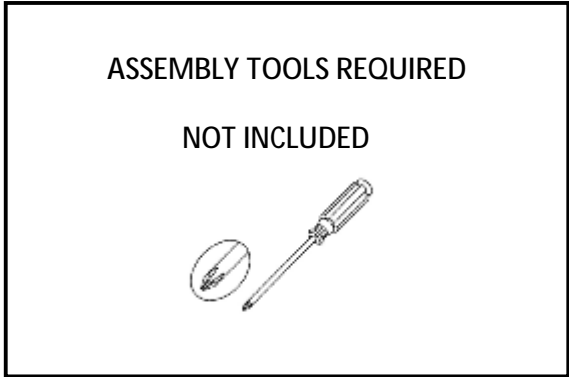

IMPORTANT NOTE:

- Place all wooden parts on a clean and smooth surface such as a rug or carpet to avoid the parts from being scratched.
- Remove all wrapping material, including staples & packing straps before you start to assemble.
- DO NOT tighten all screws and bolts until completely assembled.
- Keep all hardware parts out of reach of children.



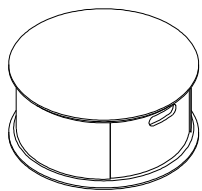

PART LIST

When unpacking, please be careful not to discard any parts with the packaging. Before continuing, please make sure you have the following parts:

NO	Description	Qty	Sketch	NO	Description	Qty	Sketch
A	Chest	1		B	Leg	4	

HARDWARE LIST

When unpacking, please be careful not to discard any parts with the packaging. Before continuing, please make sure you have all of the following hardware:

NO	Description	Qty	Sketch	NO	Description	Qty	Sketch
1	Bolt Screw (M6x40mm)	4		2	Allen key	1	

STEP 1

Slowly pull out Drawer of Chest (A) halfway, push down inside plastic and then pull Drawer out as shown below.

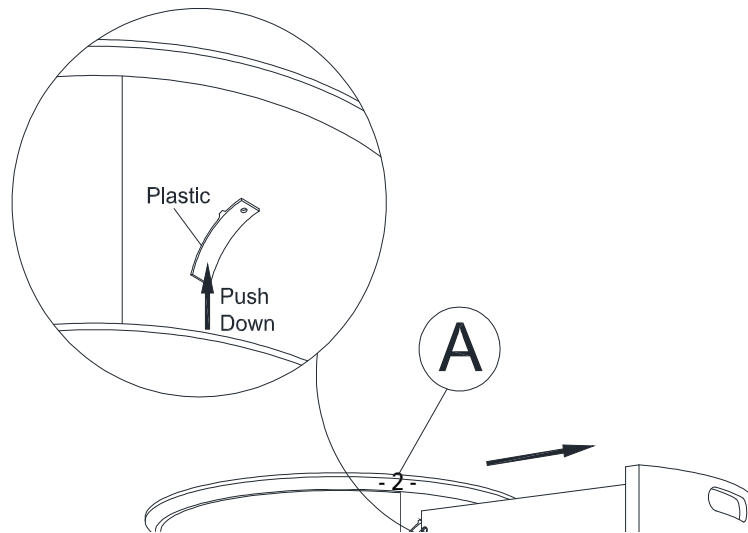

STEP 2

Attach legs (B) to the chest (A) using bolt screws (1). Tighten with Allen Key (2). Slide Drawer into the chest as shown below.

