

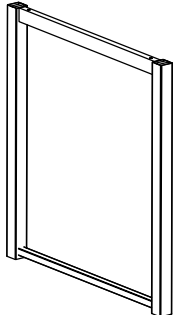

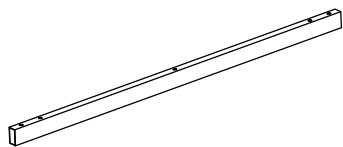

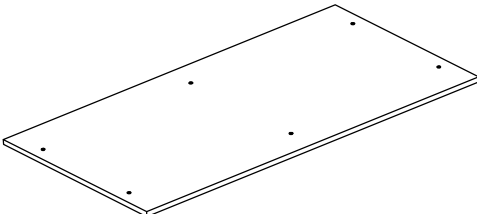

PART LIST

 <p>1</p> <p>2PCS</p>	 <p>2</p> <p>2PCS</p>	 <p>3</p> <p>1PC</p>	
 <p>4</p> <p>4PCS</p>	 <p>5</p> <p>4PCS</p>	 <p>6</p> <p>4PCS</p>	 <p>7</p> <p>2PCS</p>

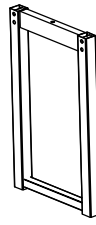
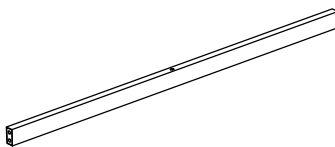
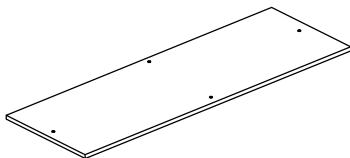
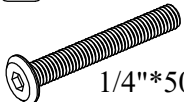
HARDWARE LIST

 <p>A</p> <p>1/4"*50 30PCS</p>	 <p>B</p> <p>Ø12*1/4"*15 16PCS</p>	 <p>C</p> <p>30*30 8PCS</p>	 <p>D</p> <p>1/4"*Ø30 4 PCS</p>	 <p>E</p> <p>4*59 1PC</p>
--	---	--	--	--

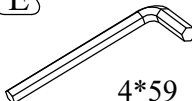
IMPORTANT SAFETY NOTICE: READ CAREFULLY BEFORE BEGINNING ASSEMBLY!

- ⚠ Hardware packs and small components should be away from the children, avoid eating and being injured
- ⚠ Please, follow with the assembly steps in order
- ⚠ Please, do not tighten any screw before each assembling unit is well placed in appropriate position
- ⚠ Please, make sure all components are fixed firmly locked without any potential safety hazard After assembly and before using
- ⚠ Please, use this product correctly, according to its purpose to avoid danger happened
- ⚠ Such as the wall fastening devices are essential parts of this product. Please fix firmly locked without any potential safety hazard before using
- ⚠ Please check all contents of this product inside of carton (s) carefully, small parts may have been lost during shipment, if any! Contact further with the retailer from which you purchased this product to obtain, do not use any substitute part
- ⚠ This assembly instructions booklet contains important safety information, please read and keep for further reference

STEP 1 : 2 SET

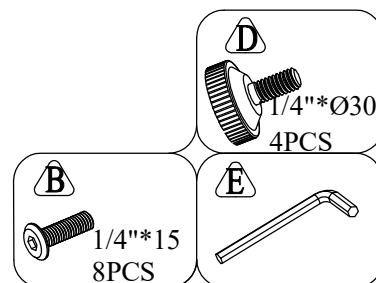
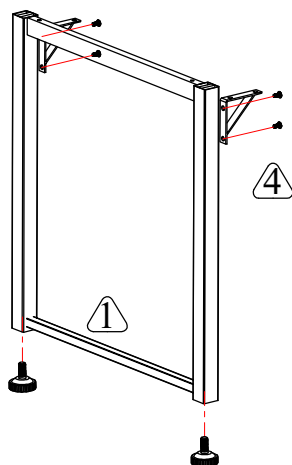

STEP 2

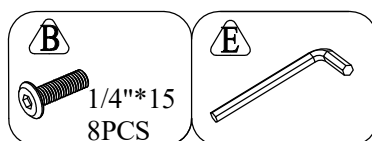
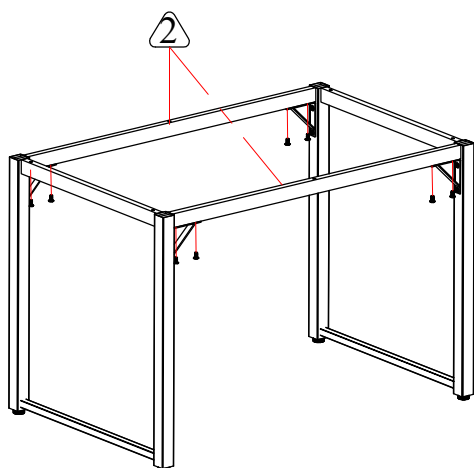

STEP 3

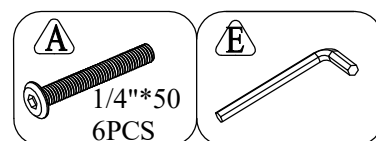
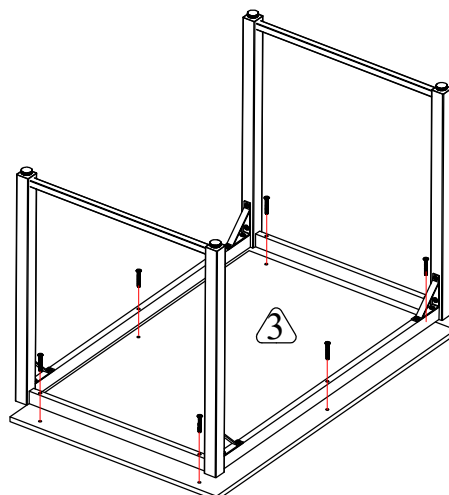

STEP 4 : 2 SET

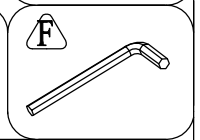
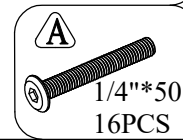
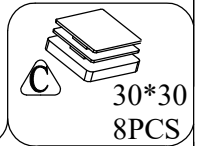
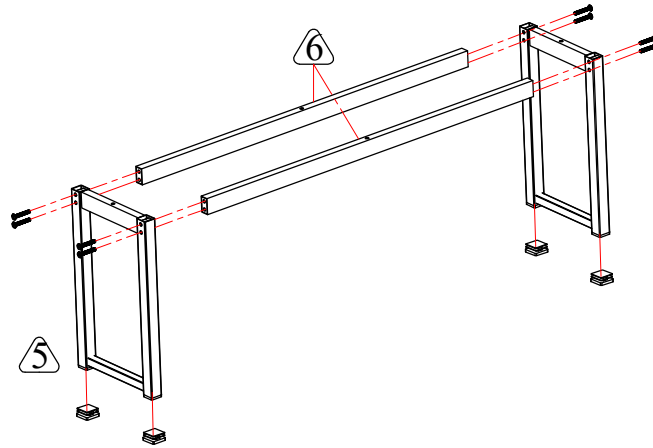

STEP 5 : 2 SET

